



Pump Basics

Pump Catalog - January 2020

MORE THAN A BRAND. WE'RE A FAMILY.

How a Centrifugal Pump Works

A centrifugal pump is a very simple design. The only moving part is an impeller attached to a shaft that is driven by the motor. The two main parts of the pump are the impeller and diffuser. The impeller can be made of bronze, stainless steel, cast iron, polycarbonate, and a variety of other materials. A diffuser or volute houses the impeller and captures the water off the impeller.

Water enters the eye of the impeller and is thrown out by centrifugal force. As water leaves the eye of the impeller, a low pressure area is created, causing more liquid to flow toward the inlet because of atmospheric pressure and centrifugal force. Velocity is developed as the liquid flows through the impeller while it is turning at high speeds on the shaft. The liquid velocity is collected by the diffuser or volute and converted to pressure by specially designed passageways that direct the flow to discharge into the piping system, or on to another impeller stage for further increasing of pressure.

The head or pressure that a pump will develop is in direct relation to the impeller diameter, the number of impellers, the eye or inlet opening size, and how much velocity is developed from the speed of the shaft rotation. Capacity is determined by the exit width of the impeller. All of these factors affect the horsepower size of the motor to be used; as the more water to be pumped or pressure to be developed, the more energy is needed.

A centrifugal pump is not positive acting. As the depth to water increases, it pumps less and less water. Also, when it pumps against increasing pressure it pumps less water. For these reasons it is important to select a centrifugal pump that is designed to do a particular pumping job. For higher pressures or greater lifts, two or more impellers are commonly used; or a jet ejector is added to assist the impellers in raising the pressure.

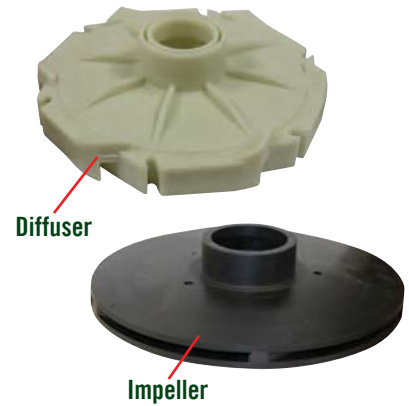

Which Pump Do I Need?

The two most popular types of pumps used for private well systems or low flow irrigation applications are jet pumps and submersible pumps.

Jet Pump

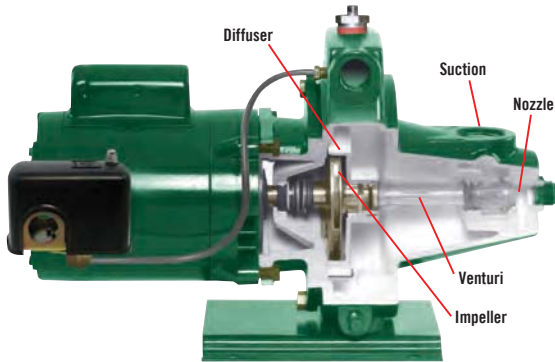

Submersible Pump End



Jet Pumps

A deep well ejector is of particular value when you have a water level that is gradually lowering. The proper jet package will be required to work efficiently.

Because jet pumps are centrifugal pumps, the air handling characteristics are such that the pump should be started with the pump and piping connections to the water supply completely filled with water.

With a shallow-well jet pump, the ejector is mounted close to the pump impeller. With a deep well jet pump, the ejector is usually mounted just above the water level in the well, or else submerged below water level.

Centrifugal pumps, both the shallow-well and deep well types have little or no ability to pump air. When starting, the pump and suction line needs to have all of the air removed. An air leak in the suction line will cause the pump to quit pumping. This is or sometimes referred to as “losing its prime”.

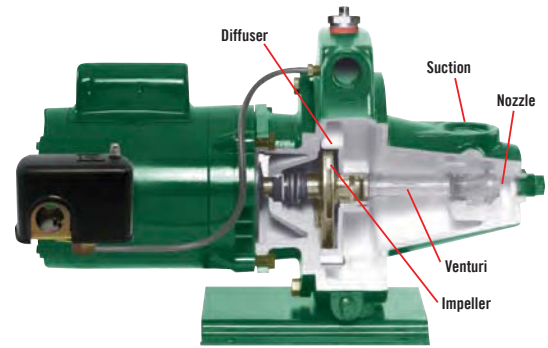

Typical Jet Pump Installation

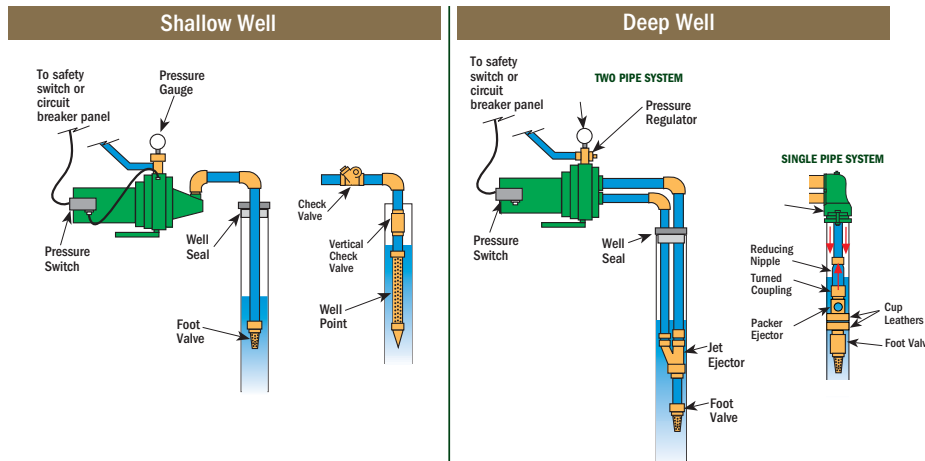

For a jet nozzle to be effective it must be combined with a venturi. The venturi changes the high-speed jet stream back to a high-pressure for delivery to the centrifugal pump. The jet and venturi are simple in appearance but they have to be well engineered and carefully matched to be efficient for various pumping conditions. The jet nozzle and venturi are also known as ejectors/ejector kits.

On a shallow-well jet pump the ejector kit (jet nozzle and venturi) is located in the pump housing in front of the impeller.

A portion of the suction water is recirculates through the ejector with the rest going to the

pressure tank. With the ejector located on the suction side of the pump, the suction is increased considerably. This enables a centrifugal pump to increase its effective suction lift from about 20 feet to as much as 28 feet, but the amount of water delivered to the storage tank becomes less as the distance from the pump to the water increases because more water has to recirculate to operate the ejector.

The difference between a deep-well jet pump and a shallow-well jet pump is the location of the ejector. The deep-well ejector is located in the well below the water level. The deep-well ejector works in the same way as the shallow-well ejector. Water is supplied to it under pressure from the pump. The ejector then returns the water plus an additional supply from the well, to a level where the centrifugal pump can lift it the rest of the way by suction.

A convertible jet pump allows for shallow-well operation with the ejector mounted on the end of the pump body. This type of pump can be converted to a deep-well jet pump by installing the ejector below the water level.

How a Jet Provides Pumping Action

Water is supplied to the Jet ejector under pressure. Water surrounding the jet stream is lifted and carried up the pipe as a result of the jet action.

When a jet is used with a centrifugal pump a portion of the water delivered by the pump is returned to the jet ejector to operate it. The jet lifts water from the well to a level where the centrifugal pump can finish lifting it by suction.

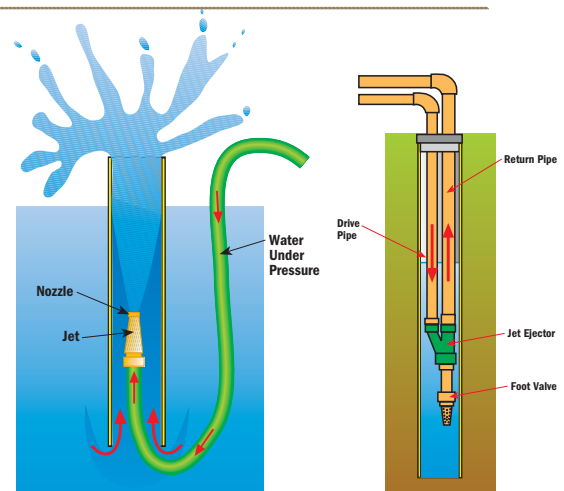

Submersible Pumps

The submersible pump is a centrifugal pump. Because all stages of the pump end (wet end) and the motor are joined and submerged in the water, it has a great advantage over other centrifugal pumps. There is no need to recirculate or generate drive water as there is with jet pumps, therefore, most of its energy goes toward “pushing” the water rather than fighting gravity and atmospheric pressure to draw water.

Virtually all submersibles are “multi-stage” pumps. All of the impellers of the multi-stage submersible pump are mounted on a single shaft and all rotate at the same speed. Each impeller passes the water to the eye of the next impeller through a diffuser. The diffuser is shaped to slow down the flow of water and convert velocity to pressure. Each impeller and matching diffuser is called a stage. As many stages are used as necessary to push the water out of the well at the required system pressure and capacity. Each time water is pumped from one impeller to the next, its pressure is increased.

The pump and motor assembly are lowered into the well by connecting piping to a position below the water level. In this way the pump is always filled with water (primed) and ready to pump. Because the motor and pump are under water they operate more quietly than above ground installations and pump freezing is not a concern.

A.Y. McDonald can stack as many impellers as needed; however, the horsepower of the motor is limited. For instance, numerous pumps have 1/2 HP ratings - pumps that are capable of pumping different flows at different pumping levels; they will, however, always be limited to 1/2 HP. Another way to look at it is that a pump will always operate somewhere along its design curve.

To get more flow, the exit width of the impeller is increased and there will then be less pressure (or head) that the pump will develop because there will be less impellers on a given HP size pump. Remember, the pump will always trade-off one for the other depending on the demand of the system. If the system demands more than a particular pump can produce, it will be necessary to go up in horsepower; thereby, allowing more impellers to be stacked or to go to a different design pump with wider impellers.



Pump Curves

A pump curve is a curved line drawn over a grid of vertical and horizontal lines. The curved line represents the performance of a given pump. The vertical and horizontal grid lines represent units of measure to display that performance.

Let's think of a well full of water. We want to use the water in a home. The home is at a higher level than the water in the well. Since gravity won't allow water to flow uphill, we use a pump. A pump is a machine used to move a volume of water a given distance. This volume is measured over a period of time expressed in gallons per minute (GPM) or gallons per hour (GPH).

The pump develops energy called discharge pressure or total dynamic head. This discharge pressure is expressed in units of measure called pounds per square inch (psi) or feet of head (ft).

NOTE: 1 psi will push a column of water up a pipe a distance of 2.31 feet. When measuring a pump's performance, we can use a curve to determine which pump is best to meet our requirements.

Figure 1 is a grid with the unit of measure in feet on the left hand side. We start with 0 at the bottom. The numbers printed as you go up the vertical axis relate to the ability of the pump to produce pressure expressed in feet. Always determine the value of each grid line. Sometimes the measure will say feet head, which is what most engineers call it.

With the pump running a reading was taken from the gauge in psi and converted to feet (1 psi = 2.31 feet).

We show another unit of measure in gallons per minute across the bottom. You start with 0 on the left. The numbers printed as you go to the right relate to the ability of the pump to produce flow of water expressed as capacity—in gallons per minute (GPM). Again, always determine the value of each grid line.

To establish a pump curve we run the pump using a gauge, valve, and flowmeter on the discharge pipe. We first run the pump with the valve closed and read the gauge. This gives us the pump's capability at 0 capacity and maximum head in feet.

Figure 2 - We mark the grid point 1. Next we open the valve to 8 GPM flow, and read the gauge. We again mark this point on the grid 2. We continue this process until we have marked all the points on the grid.

Figure 3 - We now connect all the points. This curved line is called a head/capacity curve. Head (H) is expressed in feet and capacity (C) is expressed in gallons per minute (GPM). The pump will always run somewhere on the curve.

When the total dynamic head (TDH) is known, read vertically up the left hand side of the curve to that requirement, for example, 300 feet. Then read horizontally to a point on a curve that connects to the capacity needed, for example 26 GPM. It is then determined that a 3 HP 19 stage pump is needed.

There are many different type curves shown in our catalog. Figure 4 is a composite performance curve (more than one pump) for the submersible. There is a separate curve for each horsepower size. Let's compare two sizes:

1. First look at the 1 HP, 8 stages (impellers and diffusers). At 20 GPM capacity this model will make 160 feet.
2. Now look at the 5 HP, 28 stages. At 20 GPM capacity this model will make 500 feet.

When you add impellers, the pump makes more pressure (expressed in feet). This allows the pump to go deeper in a well, but also takes more horsepower.

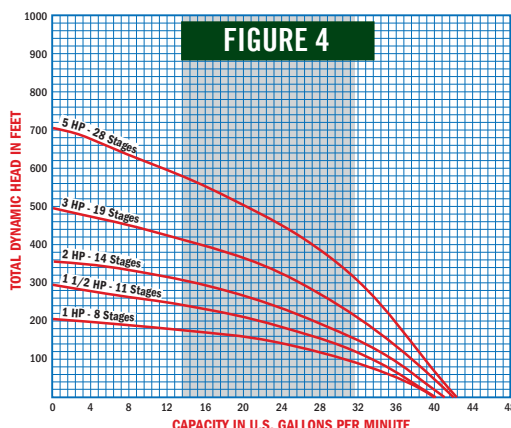
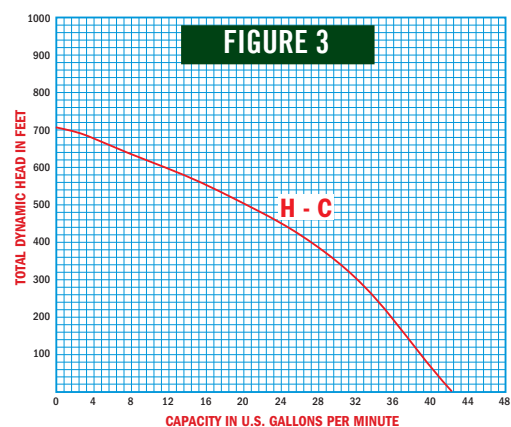
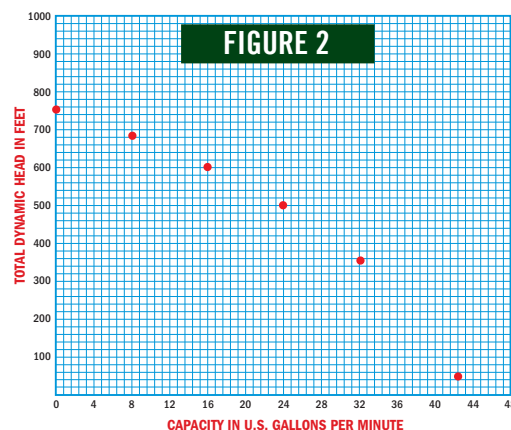
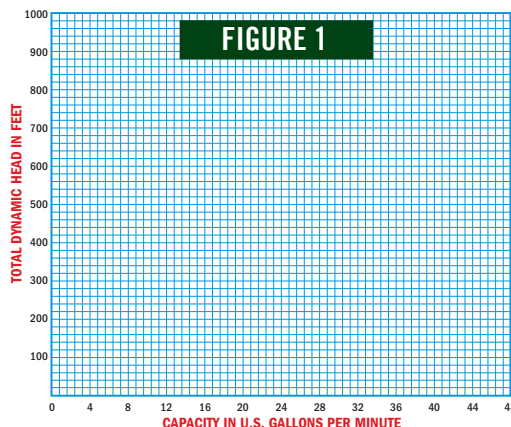

Typical Submersible Installation

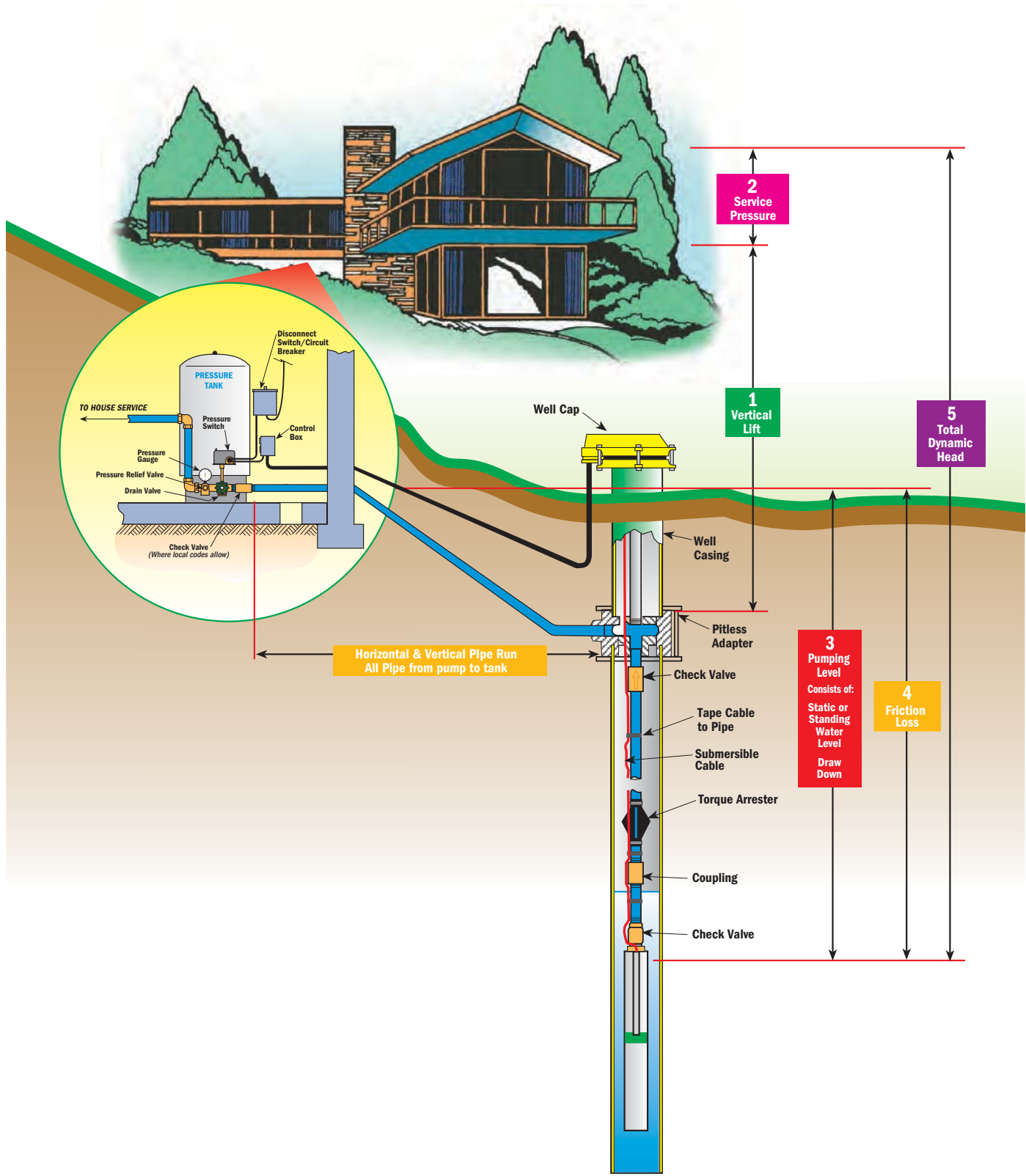

Pump Sizing - Submersible Pumps

MORE ABOUT...

VERTICAL LIFT/ ELEVATION

The vertical distance between the well head and the level at the point of use. It must be added to the TOTAL DYNAMIC HEAD if the inlet is lower than the outlet and subtracted if the inlet is higher. As a rule of good installation practice, however, pipes should slope continuously upward from the inlet to the outlet to prevent entrapment of air.

SERVICE PRESSURE

The range of pressure in the pressure tank during the pumping cycle.

PUMPING LEVEL

The lowest water level reached during pumping operation. (Static level – draw-down)

STATIC OR STANDING WATER LEVEL

The undisturbed level of water in the well before pumping. Not as important as pumping level.

DRAWDOWN

The distance that the water level in the well is lowered by pumping. It is the difference between the STATIC WATER LEVEL and the PUMPING LEVEL.

FRICTION LOSS

The loss of pressure or head due to the resistance to flow in the pipe and fittings. Friction loss is influenced by pipe size and fluid velocity, and is usually expressed in feet of head.

HORIZONTAL RUN

The horizontal distance between the point where fluid enters a pipe and the point at which it leaves.

TOTAL DYNAMIC HEAD or TDH

TDH and capacity required determines pump size. The total pressure or head the pump must develop is the sum of the VERTICAL LIFT/ELEVATION, THE SERVICE PRESSURE, PUMPING LEVEL, and THE FRICTION LOSS. All of these measurements must be expressed in the same units, usually feet of head or pressure (PSI), before adding them together.

Determining Total Dynamic Head

1 Vertical Lift / Elevation
The vertical distance in feet from the pitless adapter to the top of the pressure tank

2 Service Pressure
The average (pump shut-off) pressure switch setting x 2.31'.
Example for a 30/50 switch: 40 x 2.31' = 92.4 feet

3 Pumping Level
The vertical distance in feet from the pitless adapter or well seal to the water drawdown level in the well that yields the flow rate required by the pump

4 Friction Loss
Water flowing through piping will lose head depending on the size, type and length of piping, number of fittings, and flow rate. Example: Pumping 20 GPM through 500 ft. of 1 1/4" plastic pipe with three elbows will cause a friction loss equal to:

$$\frac{500 \text{ ft.} + 21 \text{ ft. (elbow loss)}}{100 \text{ ft.}} \times 6.00 \text{ ft (loss per 100')} = 31.26 \text{ ft.}$$

Feet of Pipe _____ Diameter of Pipe _____

Type of Pipe _____

See Friction Loss Charts on Page 16

5 Total Dynamic Head
After determining TDH, match this number with capacity required on pump curves of specific pumps in this catalog to select the correct pump.

Gallons Per Minute (or Hour) Needed

Determining Flow Rate

Although methods will vary, in general, the Water Systems Council bases pump flow selection for a residential system on total gallon usage during a seven minute peak demand period. This can be supplemented by using a properly sized pressure tank.

Farms, irrigation, and lawn sprinklers demand more water.

Well Size
(inside diameter in inches)

HEAD

+

Convert PSI to feet
(X 2.31)

+

+

=

 Ft.

Typical Jet Pump Installation

SHALLOW WATER

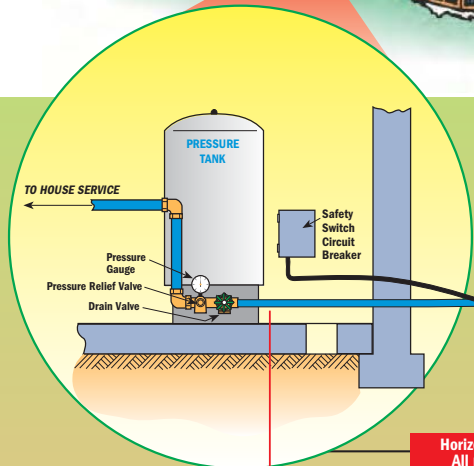

Horizontal & Vertical Pipe Run
All pipe from pump to tank

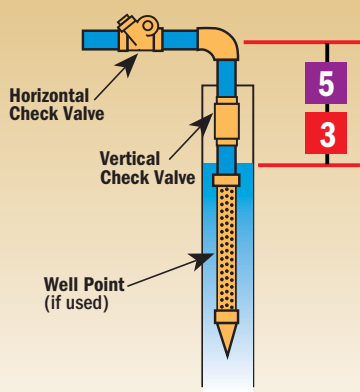
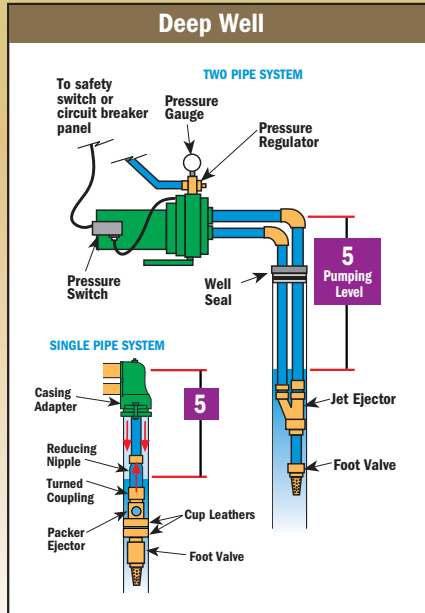
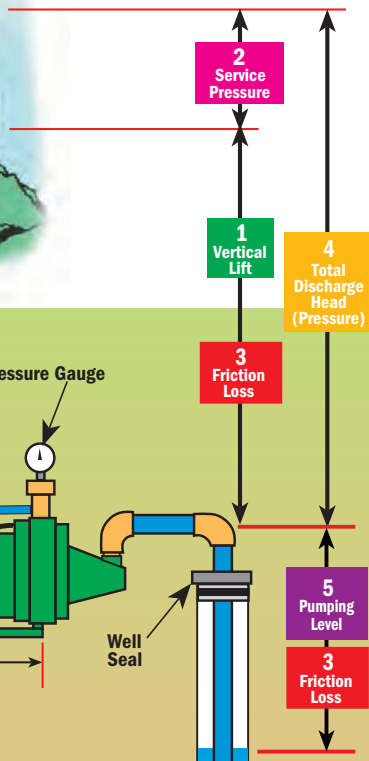
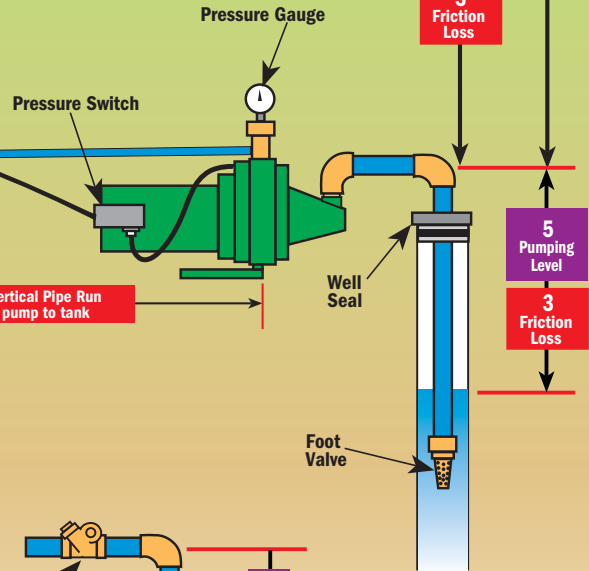

Aboveground Pumps

The difference between submersible pump and surface pump sizing is that surface pumps, including jet pumps, show performance in “charted” form versus “curves” for submersibles. Except for the “pumping level” (which is shown in feet in the charts) all other head/lift requirements should be converted to PSIG for surface pump sizing. (Feet X .433 = PSIG (Pounds per Square Inch Gauge)).

MORE ABOUT...

VERTICAL LIFT/ ELEVATION

The vertical distance between the well head and the level at the point of use. It must be ADDED to the Total Dynamic/Total Discharge Head if the inlet is lower than the outlet and SUBTRACTED if the inlet is higher. As a rule of good installation practice, however, pipes should slope continuously upward from the inlet to the outlet to prevent entrapment of air.

SERVICE PRESSURE

The range of pressure in the pressure tank during the pumping cycle.

FRICTION LOSS

The loss of pressure or head due to the resistance to flow in the pipe and fittings. Friction loss is influenced by pipe size and fluid velocity, and is usually expressed in feet of head.

HORIZONTAL RUN

The horizontal distance between the point where fluid enters a pipe and the point at which it leaves.

TOTAL DYNAMIC/TOTAL DISCHARGE HEAD or TDH

TDH and capacity required determines pump size. The total pressure or head the pump must develop is the sum of Vertical Lift/Elevation, The Service Pressure, and The Friction Loss. All of these measurements must be expressed in the same units, usually feet of head or pressure (PSI), before adding them together. For aboveground pumps, distance to water in feet are shown in the respective charts.

PUMPING LEVEL

The lowest water level reached during pumping operation. (Static level minus drawdown)

STATIC OR STANDING WATER LEVEL

The undisturbed level of water in the well before pumping. Not as important as pumping level.

DRAWDOWN

The distance that the water level in the well is lowered by pumping. It is the difference between the STATIC WATER LEVEL and the PUMPING LEVEL.

1 Vertical Lift / Elevation

The vertical distance in feet from the location of the pump to the point of highest delivery (e.g. from a pump house near the well to the second floor of a two story house)

 Feet

X .433

Well Size
(inside diameter
in inches)

 PSIG

+

2 Service Pressure

The average pressure switch setting.
Example 20/40 switch (1/2 HP) = 30 PSIG average (3/4 HP and larger pumps have 30/50 switch settings) = 40 PSIG average

 PSIG

+

3 Friction Loss

Water flowing through piping will lose head depending on the size, type and length of piping, number of fittings, and flow rate. Example: Pumping 10 GPM through 100 ft. of 1" plastic pipe with 3 elbows will cause a friction loss equal to:

 Feet

X .433

 PSIG

$$\frac{100 \text{ ft.} + 18 \text{ ft. (elbow loss)}}{100 \text{ ft.}} \times 6.31 \text{ ft (loss per 100')} = 7.44' \times .433 = 3.2 \text{ PSIG}$$

Feet of Pipe _____ Diameter of Pipe _____

Type of Pipe _____

=

See Friction Loss Charts on Page 16

4 Total Dynamic/Discharge Head • 1 + 2 + 3 =

 PSIG

5 Pumping Level/Depth to Water

The vertical distance in feet from the pump to the water level including draw down level - if any. In Shallow Well systems, referred to as suction lift/head and is limited to 20 or 25 feet at sea level (deduct 1' suction capability for each 1000' above sea level).

No need to convert-
Charts are
in feet

If 25' or less,
use shallow
well charts Ft.
If more than 25'
use deep
well charts

Note: Friction losses (3) in the suction piping must be added to the pumping level for total suction lift.

Deep Well jet pump charts include the friction losses in the vertical piping only. See page 21 if long horizontal, offset piping cannot be avoided.

Determining Flow Rate

Although methods will vary, in general, the Water Systems Council bases pump flow selection for a residential system on total gallon usage during a seven minute peak demand period. This can be supplemented by using a properly sized pressure tank.

Farms, irrigation, and lawn sprinklers demand more water.

Gallons Per Minute (or hour) Needed

See Page 20 for water demands

After determining TDH and flow requirements in GPM / GPH, match these numbers with surface pump charts in sections 3 and 4.

Friction Loss - Charts

LOSS OF HEAD IN FEET, DUE TO FRICTION PER 100 FEET OF PIPE

3/4" Pipe

FLOW US GAL MIN	STEEL C-100 ID .824"	PLASTIC C-140 ID .824"
1.5	1.13	.61
2.0	1.93	1.04
2.5	2.91	1.57
3.0	4.08	2.21
3.5	5.42	2.93
4.0	6.94	3.74
4.5	8.63	4.66
5.0	10.50	5.66
6.0	--	7.95
7.0	--	10.60

1" Pipe

FLOW US GAL MIN	STEEL C-100 ID 1.049"	PLASTIC C-140 ID 1.049"
2	.595	.322
3	1.26	.680
4	2.14	1.15
5	3.42	1.75
6	4.54	2.45
8	7.73	4.16
10	11.7	6.31
12	--	8.85
14	--	11.8

1 1/4" Pipe

FLOW US GAL MIN	STEEL C-100 ID 1.380"	PLASTIC C-140 ID 1.380"
4	.564	.304
5	.853	.460
6	1.20	.649
7	1.59	.860
8	2.04	1.10
10	3.08	1.67
12	4.31	2.33
14	5.73	3.10
16	7.34	3.96
18	9.13	4.93
20	11.10	6.00
25	--	9.06

1 1/2" Pipe

FLOW US GAL MIN	STEEL C-100 ID 1.61"	PLASTIC C-140 ID 1.61"
4	.267	.144
6	.565	.305
8	.962	.520
10	1.45	.785
12	2.04	1.10
14	2.71	1.46
16	3.47	1.87
18	4.31	2.33
20	5.24	2.83
25	7.90	4.26
30	11.1	6.0
35	--	7.94
40	--	10.20

2" Pipe

FLOW US GAL MIN	STEEL C-100 ID 2.067"	PLASTIC C-140 ID 2.067"
10	.431	.233
15	.916	.495
20	1.55	.839
25	2.35	1.27
30	3.29	1.78
35	4.37	2.36
40	5.60	3.03
45	6.96	3.76
50	8.46	4.57
55	10.10	5.46
60	11.90	6.44
70	--	8.53
80	--	10.90

2 1/2" Pipe

FLOW US GAL MIN	STEEL C-100 ID 2.469"	PLASTIC C-140 ID 2.469"
20	.654	.353
30	1.39	.750
40	2.36	1.27
50	3.56	1.92
60	4.99	2.69
70	6.64	3.58
80	8.50	4.59
90	10.60	5.72
100	--	6.90
110	--	8.25
120	--	9.71
130	--	11.30

3" Pipe

FLOW US GAL MIN	STEEL C-100 ID 3.0"	PLASTIC C-140 ID 3.068"
20	.149	.129
30	.316	.267
40	.541	.449
50	.825	.676
60	1.17	.912
70	1.57	1.22
80	2.03	1.56
90	2.55	1.95
100	3.12	2.37
110	3.75	2.84
120	4.45	3.35
130	5.19	3.90
140	6.00	4.50

4" Pipe

FLOW US GAL MIN	STEEL C-100 ID 4.0"	PLASTIC C-140 ID 4.026"
20	.038	.035
30	.076	.072
40	.128	.120
50	.194	.179
60	.273	.250
70	.365	.330
80	.470	.422
90	.588	.523
100	.719	.613
110	.862	.732
120	1.02	.861
130	1.19	1.00
140	1.37	1.15

Example:

10 GPM with 1' plastic pipe has 6.31' of loss per 100 ft. - if your run is 50 ft., multiply by .5, if 250 ft. multiply by 2.5, etc.

Loss through fittings in terms of equivalent lengths of pipe

TYPE FITTING & APPLICATION	PIPE & FTG. MATERIAL (Note 1)	EQUIVALENT LENGTH OF PIPE NOMINAL SIZE FITTING & PIPE								TYPE FITTING & APPLICATION	PIPE & FTG. MATERIAL (Note 1)	EQUIVALENT LENGTH OF PIPE NOMINAL SIZE FITTING & PIPE							
		1/2	3/4	1	1 1/4	1 1/2	2	2 1/2	1/2			3/4	1	1 1/4	1 1/2	2	2 1/2		
Insert coupling	Plastic	3	3	3	3	3	3	3	Standard tee Flow through side	Steel	4	5	6	8	9	11	14		
Threaded adapter Plastic or copper to thread	Copper	1	1	1	1	1	1	1		Copper	4	5	6	8	9	11	14		
	Plastic	3	3	3	3	3	3	3		Plastic	7	8	9	12	13	17	20		
90° standard elbow	Steel	2	3	3	4	4	5	6		Gate valve	Note 2	2	3	4	5	6	7	8	
	Copper	2	3	3	4	4	5	6	Swing check valve		Note 2	4	5	7	9	11	13	16	
	Plastic	4	5	6	7	8	9	10											

Note 1: Loss figures are based on equivalent lengths of indicated pipe material

Note 2: Loss figures are for screwed valves and are based on equivalent lengths of steel pipe

Note 3: Loss figures for copper lines are approximately 10% higher than shown for plastic

Pressure Tank - Sizing

TANK OPERATIONS

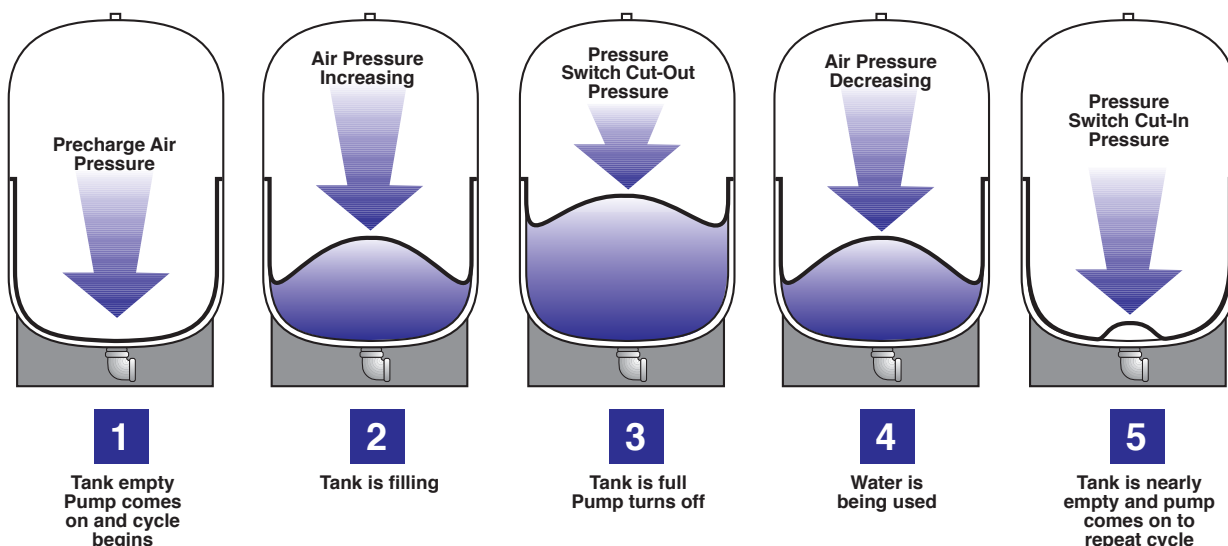

Why do I need a tank?

There are four main reasons to include a tank in your system:

1. To protect and extend the life of the pump by reducing the number of cycles.
2. To provide storage of water under pressure for delivery between cycles.
3. To have reserve capacity for periods of peak demand.
4. To reduce system maintenance.

How do I choose a tank for my system?

Choosing the proper tank for your pumping system will greatly reduce the risk of premature pump failure. Most manufacturers recommend a **minimum** run time of one minute in order to protect the pump and the pump motor. The larger the tank the longer the running time and fewer pump cycles will result in longer pump life. One HP and larger pumps require longer run times.

To determine the proper size of tank, there are three factors to consider:

1. Pump flow rate in gallons per minute
2. Desired run time of the pump
3. Cut-in and cut-out psi of the pressure switch

From these factors you can determine the tank drawdown with the following equation:

Pump flow rate X run time = tank drawdown capacity required.

Tank drawdown capacity is the minimum amount of water stored and/or delivered by the pressure tank between pump shut-off and pump re-start. This should not be confused with "tank volume." For example, a pre-charged tank with a tank volume of 20 gallons has only five to seven gallons drawdown capacity depending on the cut-in / cut-out (on/off) setting of the pressure switch.

Pumps with flow rates (capacities) up to 10 GPM should have a tank with a minimum of one gallon drawdown capacity for each GPM delivered by the pump. Example: 10 GPM pump = 10 gallon "drawdown".

Pump flow rates from 11 to 20 GPM should have tank drawdowns approximately 1.5 times the GPM rating.

For example, 20 GPM X 1.5 = 30 gallon "drawdown".

Pump flow rates above 20 GPM should have tank drawdowns approximately two times the GPM rating and multiple tanks should be considered.

(CHECK YOUR TANK MANUFACTURER'S CHARTS FOR TANK DRAWDOWN RATING.)

Technical Data - Glossary

ACIDITY - A condition of water when the pH is below 7. See pH.

ALKALINITY - A condition of water when the pH is above 7. See pH.

AQUIFER - A water-saturated geologic unit or system that yields water to wells or springs at a sufficient rate that the wells or springs can serve as practical sources of water.

ARTESIAN WELL (flowing and non-flowing) - Well in which the water rises above the surface of the water in the aquifer after drilling is completed. It is a flowing artesian well if the water rises above the surface of the earth.

CENTRIFUGAL - Consists of a fan-shaped impeller rotating in a circular housing, pushing liquid towards a discharge opening. Simple design, only wearing parts are the shaft seal and bearings (if so equipped). Usually used where a flow of liquid at relatively low pressure is desired. Not self-priming unless provided with a priming reservoir or foot valve: works best with the liquid source higher than the pump (flooded suction/gravity feed). As the discharge pressure (head) increases, flow and driven power requirements decrease. Maximum flow and motor loading occur at minimum head.

CHECK VALVE - Allows liquid to flow in one direction only. Generally used in suction and discharge line to prevent reverse flow.

CISTERN - A non-pressurized tank (usually underground) for storing water.

COAGULATION - The chemically combining of small particles suspended in water.

CONTAMINATED WATER - Water that contains a disease causing or toxic substances.

DEEP WELL - Use a pump (submersible or deep well jet) to force water upward from a pumping element below the well water level. Not restricted by suction lift limitations.

DRAWDOWN - The vertical distance the water level drops in a well pumped at a given rate.

DYNAMIC HEAD - Vertical distances (in feet) when the pump is running/producing water.

FLOODED SUCTION - Liquid source is higher than pump and liquid flows to pump by gravity (Preferable for centrifugal pump installations).

FLOW - The measure of the liquid volume capacity of a pump. Given in Gallons Per Hour (GPH) or Gallons Per Minute (GPM), as well as Cubic Meters Per Hour (CMPH), and Liters Per Minute (LPM).

FOOT VALVE - A type of check valve with a built-in strainer. Used at point of liquid intake to retain liquid in the system, preventing loss of prime when liquid source is lower than pump.

FRICTION LOSS - The loss of pressure or head due to the resistance to flow in the pipe and fittings. Friction loss is influenced by pipe size and fluid velocity, and is usually expressed in feet of head.

GRAINS PER GALLON - The weight of a substance, in grains, in a gallon. Commonly, grains of minerals per gallon of water as a measure of water hardness. 1 gpg = 17.1 mg/l.

GROUND WATER - Water that has filtered down to a saturated geologic formation beneath the earth's surface.

HARDNESS MINERALS - Minerals dissolved in water that increase the scaling properties and decrease cleansing action - usually calcium, iron, and magnesium.

HEAD - Another measure of pressure, expressed in feet. Indicates the height of a column of water being lifted by the pump neglecting friction losses in piping.

INCRUSTATION - A mineral scale chemically or physically deposited on wetted surfaces, such as well screens, gravel packs, and in tea kettles.

INTERMEDIATE STORAGE - A holding tank included in a water system when the water source does not supply the peak use rate.

JET PUMP - A pump combining two pumping principles - centrifugal operation and ejection. Can be used in shallow or deep wells.

MILLIGRAMS PER LITER (mg/l) - The weight of a substance, in milligrams in a liter. 1 mg/l = 1 oz. per 7500 gallons. It is equivalent to 1 ppm. See Parts per Million.

NEUTRALITY - A condition of water when the pH is at 7. See pH.

Technical Data - Glossary

OXIDATION - A chemical reaction between a substance and oxygen.

PALATABLE WATER - Water of acceptable taste. May also include non-offensive appearance and odor.

PARTS PER MILLION, ppm - A measure of concentration; one unit of weight or volume of one material dispersed in one million units of another; e.g., chlorine in water, carbon monoxide in air. Equivalent to indicate small size of this unit: 1 ppm = 1 oz. per 7500 gallons; 1 kernel of corn in 13 bushels 1/4 sq. in. in an acre.

PEAK USE RATE - The flow rate necessary to meet the expected maximum water demand in the system.

pH - A measure of the acidity or alkalinity of water. Below 7 is acid, above 7 is alkaline.

POLLUTED WATER - Water containing a natural or man-made impurity.

POTABLE WATER - Water safe for drinking.

PRESSURE - The force exerted on the walls of a container (tank pipe, etc.) by the liquid. Measured in pounds per square inch (PSI).

PRIME - A charge of liquid required to begin pumping action of centrifugal pumps when liquid source is lower than pump. May be held in pump by a foot valve on the intake line or a valve or chamber within the pump.

RELIEF VALVE - Usually used at the discharge of a pump. An adjustable, spring-loaded valve opens, or relieves pressure when a pre-set pressure is reached. Used to prevent excessive pressure and pump or motor damage if discharge line is closed off.

SHALLOW WELL - Use a pump located above ground to lift water out of the ground through a suction pipe. Limit is a lift of 33.9 feet at sea level.

SOFTENING - The process of removing hardness caused by calcium and magnesium minerals.

SPRING - A place on the earth's surface where ground water emerges naturally.

STATIC HEAD - Vertical Distance (in feet) from pump to point of discharge when the pump is not running.

STRAINERS - A device installed in the inlet of a pump to prevent foreign particles from damaging the internal parts.

SUBMERGENCE / SETTING - The vertical distance between PUMPING LEVEL and the bottom of the pump or jet assembly. Submergence must be sufficient to insure that the suction opening of the pump or jet assembly is always covered with water, while maintaining enough clearance from the bottom of the well to keep it out of sediment (at least 10 foot clearance is recommended). Could be useful when figuring friction loss.

SUBMERSIBLE - A pump which is designed to operate totally submersed in the fluid which is being pumped. With water-proof electrical connections, using a motor which is cooled by the liquid.

SUMP - A well or pit in which liquids collect below floor level.

SURGING - Forcing water back and forth rapidly and with more than normal force in a well or other part of the water system.

TOTAL HEAD - The sum of discharge head suction lift and friction losses.

VISCOSITY - The thickness of a liquid, or its ability to flow. Temperature must be stated when specifying viscosity, since most liquids flow more easily as they get warmer. The more viscous the liquid the slower the pump speed required.

WATER TABLE WELL - A well where the water level is at the surface of the aquifer.

WATER TREATMENT - A process to improve the quality of water.

WATER WELL - A man-made hole in the earth from which ground water is removed.

WELL DEVELOPMENT - A process to increase or maintain the yield of a well.

Technical Data

MEASUREMENT CONVERSION FACTORS (APPROXIMATE)

Metric	x	Conversion Factor	=	Customary	Customary	x	Conversion Factor	=	Metric
LENGTH					LENGTH				
mm	millimeter 0.04	inches	in	in	inches 2.54	centimeters	cm
cm	centimeters 0.4	inches	in	ft	feet 30.5	centimeters	cm
m	meters 3.3	feet	ft	yd	yards 0.9	meters	m
m	meters 1.1	yards	yd	mi	miles 1.6	kilometers	km
km	kilometers 0.6	miles	mi					
AREA					AREA				
cm ²	square centimeters 0.16	square inches	in ²	in ²	square inches 6.5	square centimeters	cm ²
m ²	square meters 1.2	square yards	yd ²	ft ²	square feet 0.09	square meters	m ²
km ²	square kilometers 0.4	square miles	mi ²	yd ²	square yards 0.8	square meters	m ²
ha	hectares (10,000 m ²) 2.5	acres	mi ²	mi ²	square miles 2.6	square kilometers	km ²
					a acres 0.4 hectares ha				
MASS (weight)					MASS (weight)				
g	grams 0.035	ounces	oz	oz	ounces 28	grams	g
kg	kilograms 2.2	pounds	lb	lb	pounds 0.45	kilograms	kg
t	tonnes(1000kg) 1.1	shorttons			short tons (2000 lb) 0.9	tonnes	t
VOLUME					VOLUME				
ml	milliliters 0.03	fluid ounces	n oz	tsp	teaspoons 5	milliliters	ml
l	liters 2.1	pints	pt	tbsp	tablespoons 15	milliliters	ml
l	liters 1.06	quarts	qt	fl oz	fluid ounces 30	milliliters	ml
l	liters 0.26	gallons	gal	c	cups 0.24	liters	
m ³	cubic meters 35.3	cubicfeet	ft ³	pt	pints 0.47	liters	
m ³	cubic meters 1.3	cubic yards	yd ³	qt	quarts 0.95	liters	
m ³	cubic meters 264.2	gallons	gal.	gal	gallons 3.8	liters	
					ft ³ cubic feet 0.03 cubic meters m ³				
					yd ³ cubic yards 0.76 cubic meters m ³				
					gal gallons0038 cubic meters m ³				
FORCE/AREA					FORCE/AREA				
kPa	kilo paschals145	pound force/in ²	psi	psi	pound force/in ² 6.89	kilo paschals	kPa
bar	bar 14.5	pound force/in ²	psi	psi	pound force/in ²069	bar	bar

Average water requirements for general service around the home and farm

Each person, per day for all purposes 100 gal.
Each horse, dry cow or beef animal 12 gal.
Each milking cow 35 gal.

Each hog per day 4 gal.
Each sheep per day 2 gal.
For 100 chickens per day 4 gal.

Average amount of water required by various home and yard fixtures

Drinking fountain 50-100 gal./day
Each shower 25-60 gal. @ 5 GPM
To fill bathtub 35 gal.
To flush toilet 3-7 gal.
To fill lavatory 1-2 gal.

To sprinkle 1/4" of water on each 1000 sq. ft. of lawn 160 gal.
Dishwasher 10-20 gal. @ 2 GPM
Washer up to 50 gal. @ 4-6 GPM
Regeneration of water softener up to 150 gal.

Average flow rate requirements by various fixtures GPM = Gal. per minute • GPH = Gal. per hour

Shower 3-5 GPM
Bathtub 3-5 GPM
Toilet 4 GPM
Lavatory 4 GPM
Kitchen sink 5 GPM
1/2" hose & nozzle 3 GPM
3/4" Hose & nozzle 6 GPM
Lawn sprinkler 3-7 GPM

Technical Data

CENTRIFUGAL PUMPS | FORMULAS | CONVERSION FACTORS

Pipe velocity (ft. per second) = $\frac{.408 \times \text{GPM}}{(\text{pipe diameter})^2} = \frac{.321 \times \text{GPM}}{\text{pipe area}}$
Velocity head (feet) = $\frac{(\text{pipe velocity ft. per second})^2}{64.4}$
Water horsepower = $\frac{\text{GPM} \times \text{head in ft.} \times \text{specific gravity}}{3960}$
Brake horsepower (pump) = $\frac{\text{GPM} \times \text{head in ft.} \times \text{specific gravity}}{3960 \times \text{pump efficiency}}$
Efficiency (pump) = $\frac{\text{GPM} \times \text{head in ft.} \times \text{specific gravity}}{3960 \times \text{BHP}} = \frac{\text{WHP}}{\text{BHP}}$
Brake horsepower (motor) = $\frac{\text{Watts input} \times \text{motor efficiency}}{746}$
Pressure (lbs. per sq. in.) = $\frac{\text{Head ft.} \times \text{specific gravity}}{2.31'} = \frac{\text{Head ft.} \times \text{specific gravity} \times .433}{.433}$
Head feet = $\frac{\text{Lbs. per sq. in.} \times 2.31'}{\text{Specific gravity}}$
Lbs. per square in. = Head in ft. x .433 • Head in ft. = lbs. per sq. in. x 2.31'

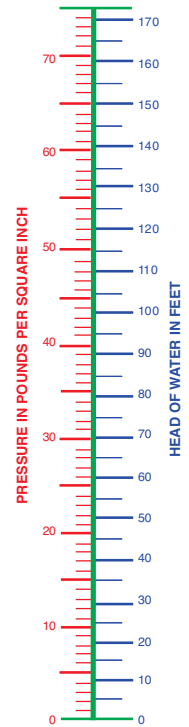

Offset Jet Pump - Pipe Friction

When the jet pump is offset horizontally from the well site, add the following distances to the vertical lift to approximate capacity to be received. **Friction loss in feet per 100 feet offset • Friction loss is to be added to vertical lift**

JET SIZE HP	1 1/4 x 1	1 1/4 x 1 1/4	1 1/2 x 1 1/4	1 1/2 x 1 1/2	2 x 1 1/2	2 x 2	2 1/2 x 2	2 1/2 x 2 1/2	3 x 2 1/2	3 x 3
1/3	12	8	6	4						
1/2	18	12	8	6	3	2				
3/4	30	22	16	11	6	4				
1		30	25	16	9	6				
1 1/2					13	8	5	3		
2					20	13	7	5		
3							13	9	6	4

Example: Vertical distance to water is 60 feet, but a 100 feet horizontal / offset (run of piping) is required. A 3/4 HP jet pump is used so the capacity should be taken from the “80’ depth to water” performance. For example: 60 feet to water + 22 feet friction loss (with 1 1/4 x 1 1/4 two pipe system) = 82 feet, which is approximately 80 feet.

Installation of a Long Tail Pipe on Deep Well Jet Pumps

The pumping capacity of a deep well jet pump can be reduced to equalize with the well flow by installing a 35 foot tail pipe below the jet assembly.

With a tail pipe, pump delivery remains at 100% of capacity down to the ejector level. If water level falls below that, flow decreases in proportion to drawdown as shown by figures. When delivery equals well inflow, the water level remains constant until the pump shuts off. The pump will not lose prime with this tail pipe arrangement.

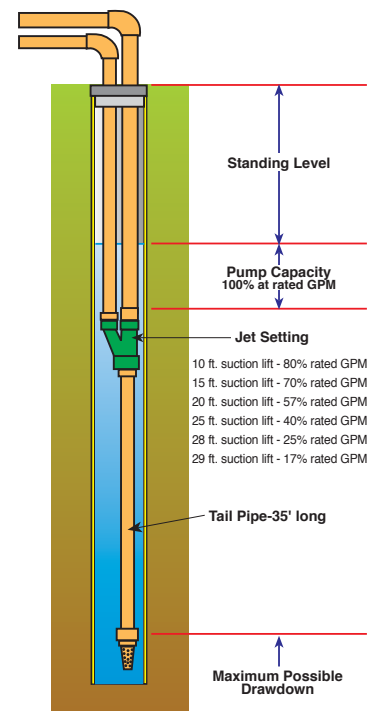

Drop Cable Selection Chart

Single-Phase, Two or Three Wire Cable, 60 HZ (Service Entrance to motor)

Motor Rating			Copper Wire Size													
Volts	HP	KW	14	12	10	8	6	4	3	2	1	0	00	000	0000	
115	1/2	.37	100	160	250	390	620	960	1190	1460	1780	2160	2630	3140	3770	
	3/4	.55	400	650	1020	1610	2510	3880	4810	5880	7170	8720				
230	1	.75	300	480	760	1200	1870	2890	3580	4370	5330	6470	7870			
	1.5	1.1	250	400	630	990	1540	2380	2960	3610	4410	5360	6520			
	2	1.5	190	310	480	770	1200	1870	2320	2850	3500	4280	5240			
	3	2.2	150	250	390	620	970	1530	1910	2360	2930	3620	4480			
	5	3.7	120*	190	300	470	750	1190	1490	1850	2320	2890	3610			
	7.5	5.5	0	0	180*	280	450	710	890	1110	1390	1740	2170	2680		
	10	7.5	0	0	0	200*	310	490	610	750	930	1140	1410	1720		
	15	11	0	0	0	0	250*	390	490	600	750	930	1160	1430	1760	
				0	0	0	0	170*	270*	340	430	530	660	820	1020	1260

1 foot = .3048 meter

Three-Phase, Three Wire Cable, 60 HZ 200 and 300 volts (Service Entrance to motor)

Motor Rating			Copper Wire Size (1)													
Volts	HP	KW	14	12	10	8	6	4	3	2	1	0	00	000	0000	
200V 60 Hz	1/2	.37	710	1140	1800	2840	4420									
	3/4	.55	510	810	1280	2030	3160									
	1	.75	430	690	1080	1710	2670	4140	5140							
	1.5	1.1	310	500	790	1260	1960	3050	3780							
	2	1.5	240	390	610	970	1520	2360	2940	3610	4430	5420				
	3	2.2	180	290	470	740	1160	1810	2250	2760	3390	4130				
	5	3.7	110*	170	280	440	690	1080	1350	1660	2040	2490	3050	3670	4440	
	7.5	5.5	0	0	200	310	490	770	960	1180	1450	1770	2170	2600	3150	
	10	7.5	0	0	0	230*	370	570	720	880	1090	1330	1640	1970	2390	
	15	11	0	0	0	160*	250*	390	490	600	740	910	1110	1340	1630	
300V 60 Hz	20	15	0	0	0	0	190*	300*	380	460	570	700	860	1050	1270	
	25	18.5	0	0	0	0	0	240*	300*	370*	460	570	700	840	1030	
	30	22	0	0	0	0	0	0	250*	310*	380*	470	580	700	850	
	1/2	.37	930	1490	2350	3700	5760	8910								
	3/4	.55	670	1080	1700	2580	4190	6490	8060	9860						
	1	.75	560	910	1430	2260	3520	5460	6780	8290						
	1.5	1.1	420	670	1060	1670	2610	4050	5030	6160	7530	9170				
	2	1.5	320	510	810	1280	2010	3130	3890	4770	5860	7170	8780			
	3	2.2	240	390	620	990	1540	2400	2980	3660	4480	5470	6690	8020	9680	
	5	3.7	140*	230	370	590	920	1430	1790	2190	2690	3290	4030	4850	5870	
Three Phase Wire	7.5	5.5	0	160*	260	420	650	1020	1270	1560	1920	2340	2870	3440	4160	
	10	7.5	0	0	190*	310	490	760	950	1170	1440	1760	2160	2610	3160	
	15	11	0	0	0	210*	330	520	650	800	980	1200	1470	1780	2150	
	20	15	0	0	0	0	250*	400	500	610	760	930	1140	1380	1680	
	25	18.5	0	0	0	0	0	320*	400	500	610	750	920	1120	1360	
	30	22	0	0	0	0	0	260*	330*	410*	510	620	760	930	1130	
	460V 60 Hz	1/2	.37	3770	6020	9460										
		3/4	.55	2730	4350	6850										
		1	.75	2300	3670	5770	9070									
		1.5	1.1	1700	2710	4270	6730									
2		1.5	1300	2070	3270	5150	8050									
3		2.2	1000	1600	2520	3970	6200									
5		3.7	590	950	1500	2360	3700	5750								
7.5		5.5	420	680	1070	1690	2640	4100	5100	6260	7680					
10		7.5	310	500	790	1250	1960	3050	3800	4680	5750	7050				
15		11	0	340*	540	850	1340	2090	2600	3200	3930	4810	5900	7110		
Three Phase Wire	20	15	0	0	410*	650	1030	1610	2000	2470	3040	3730	4580	5530		
	25	18.5	0	0	0	530*	830	1300	1620	1990	2450	3010	3700	4470	5430	
	30	22	0	0	0	430*	680	1070	1330	1640	2030	2490	3060	3700	4500	
	40	30	0	0	0	0	500*	790	980	1210	1490	1830	2250	2710	3290	
	50	37	0	0	0	0	0	640*	800	980	1210	1480	1810	2190	2650	
	60	45	0	0	0	0	0	540*	670*	830*	1020	1250	1540	1850	2240	
	75	55	0	0	0	0	0	0	680*	840*	1030	1260	1520	1850		
	100	75	0	0	0	0	0	0	0	620*	760*	940*	1130	1380		
	125	90	0	0	0	0	0	0	0	0	0	740*	890*	1000*		
	150	110	0	0	0	0	0	0	0	0	0	0	0	760*	920*	
175	130	0	0	0	0	0	0	0	0	0	0	0	0	810*		
200	150	0	0	0	0	0	0	0	0	0	0	0	0	0		

Lengths marked * meet the U.S. National Electrical Code ampacity only for individual conductor 75°C cable. Only the lengths without * meet the code for jacketed 75°C cable. Local code requirements may vary.

CAUTION!! Use of wire sizes smaller than determined above will void warranty, since low starting voltage and early failure of the unit will result. Larger wire sizes (smaller numbers) may always be used to improve economy of operation.

(1) If aluminum conductor is used, multiply above lengths by 0.61. Maximum allowable length of aluminum wire is considerably shorter than copper wire of same size.